

Calvert





Inspired by Calvert Vaux, the mastermind behind New York's Central Park.
Breaking up a grid system to create spaces to focus, collaborate,
relax and inspire.

Steel frame walls, available in three heights, act as room dividers, with the louvre-style grid pattern diffusing visibility between areas without creating a definite wall.

Accessories, such as display cubes, shelves, AV boxes, dry-wipe surfaces and upholstered panels, along with benches and desk surfaces, can be incorporated to add flexible functionality.

Infinitely scalable, the system can grow, adapt and be reconfigured as spaces evolve and can be used to create landscapes from simple partitions to all-encompassing 'room-within-a-room' environments.

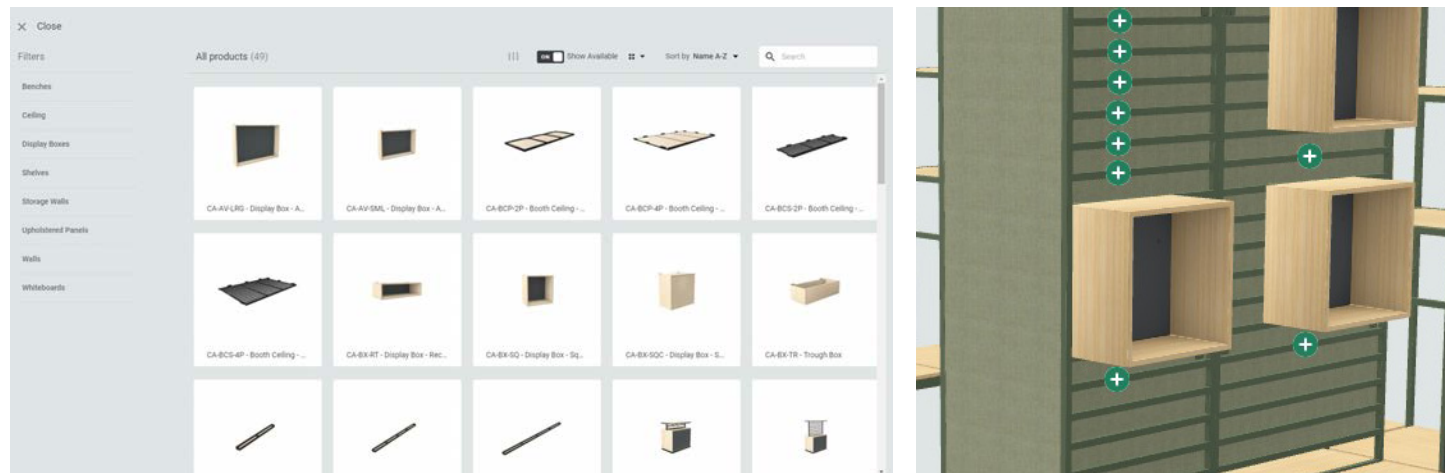
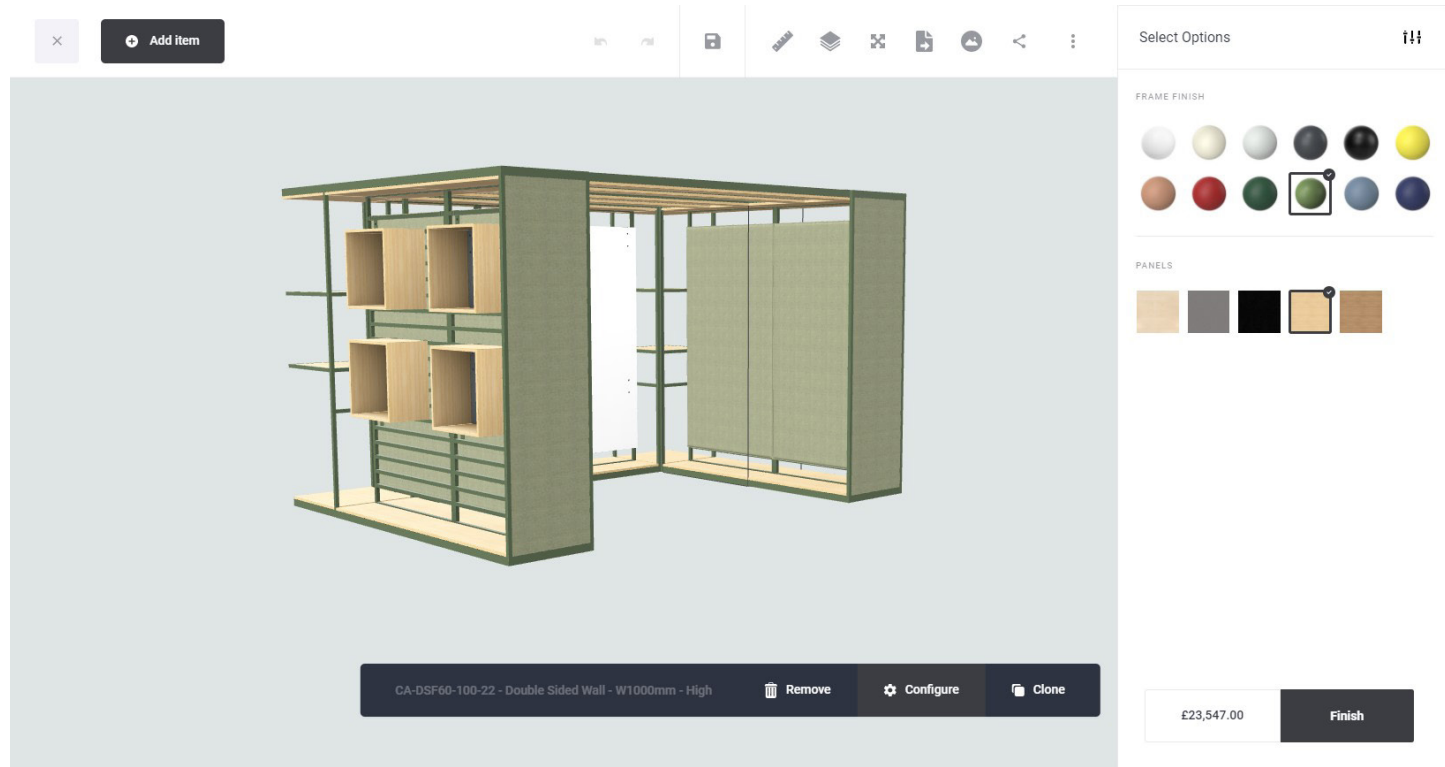

Our online product configurator allows customers to build and specify their perfect **Calvert** layout in 3D simply and easily.

Wall frames can be assembled in any number of ways within the parameters of the system, with Link Frames automatically inserted to alleviate any errors in construction.

Finishes and materials can be selected to customise the look of the product to tie in with your scheme.

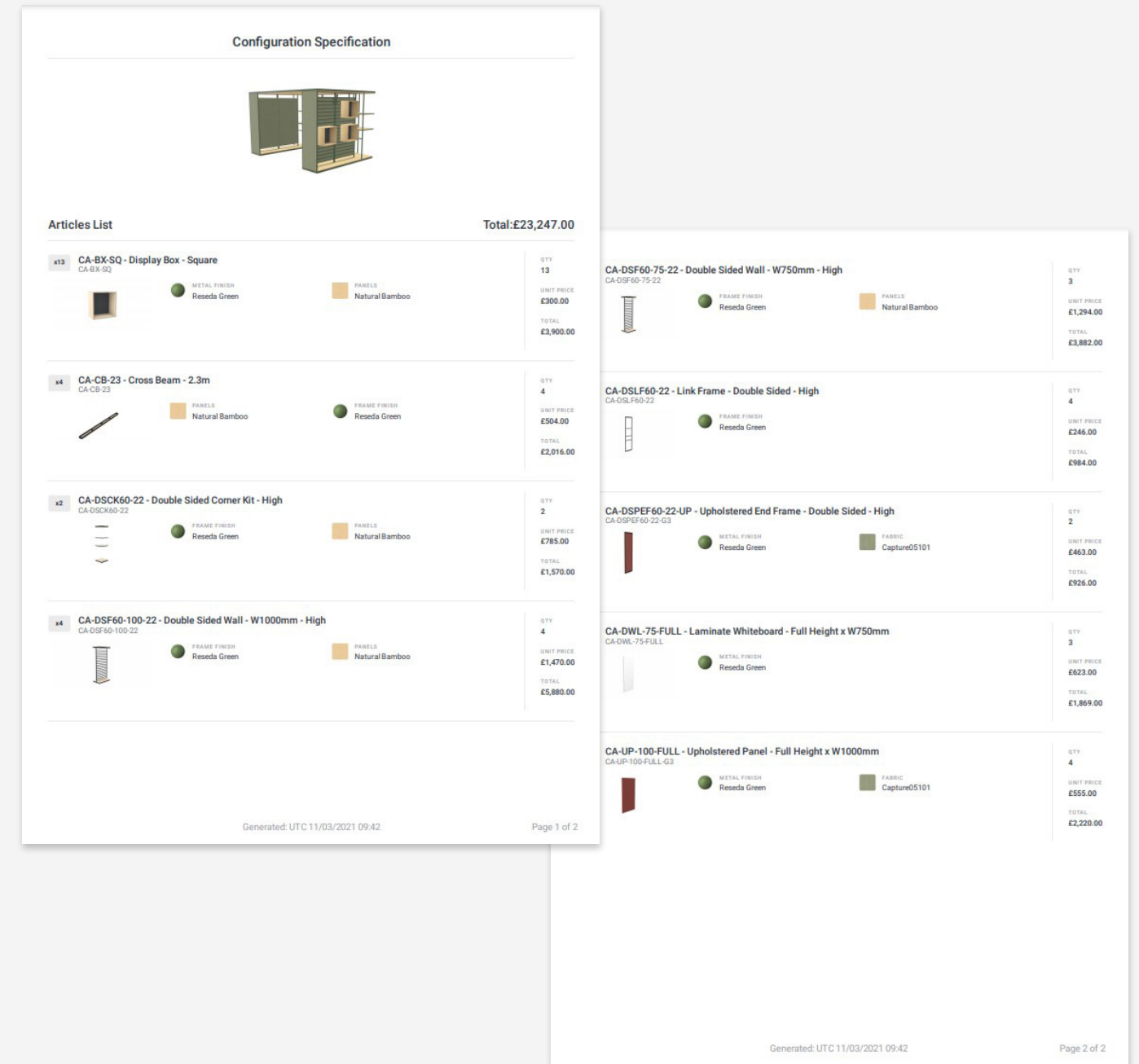

Once your perfect layouts are completed they can be shared with other users. High quality images from any view point can be generated for use in presentations, 3D files can be downloaded for integration into CAD models and a full component list, including finishes, created to aid in ordering.

Registered users can also access pricing, making specification, costing and ordering as simple as possible.

Contact a member of the Sales Team to arrange a quick training session and set up your account access.



Mid Height Storage Wall

Product Codes

- 2x CA-DSCB100-15
- 2x CA-DSEF60-15

Dimensions

W2050 x D600
x H1000mm



Space Divider with Meeting Table

- 3x CA-DSF60-100-22
- 2x CA-DSEF60-22
- 1x CA-ST-140

W3050 x D1715
x H2200mm



Four Person Booth with Benches and Ceiling

Group 3 Fabrics

- 7x CA-SSF30-75-22
- 2x CA-SSEF30-22
- 4x CA-SSLF30-22
- 2x CA-SSCK30-22-2W
- 1x CA-BCP-4P
- 1x CA-SFPB-2-R
- 1x CA-SFPB-2-L
- 1x CA-ST-140

Product Codes

W2950 x D1890
x H2200mm

Dimensions



Corner Divider Layout with Cupboards

- 2x CA-DSF60-100-22
- 1x CA-DSF60-100-10
- 2x CA-CB100-22
- 1x CA-CB100-15
- 1x CA-CB100-10
- 4x CA-DSL60-22
- 1x CA-DSL60-15
- 2x CA-DSEF60-10
- 1x CA-DSC60-22-2W

W3650 x D4650
x H2200mm



Space Divider with Drop-in Desks

Product Codes

- 4x CA-DSF60-75-22
- 2x CA-DSSF60-22
- 4x CA-DID-150

Dimensions

W3050 x D1225
x H2200mm



Space Divider with Double Sided Benches

Group 3 Fabrics

- 3x CA-DSF60-100-22
- 2x CA-DSF60-75-22
- 2x CA-DSEF60-22
- 6x CA-RFPB-2

W4550 x D1460
x H2200mm

Product Codes

Dimensions



Divider with Drop-In Desks & Cupboard

- 3x CA-DSF60-75-22
- 2x CA-DSL60-22
- 1x CA-DSF60-75-10
- 1x CA-DSEF60-10
- 1x CA-CB100-15
- 1x CA-DSEF60-15
- 6x CA-DID-75

W3350 x D1225
x H2200mm



Single-Sided Wall Fixed Setup with Benches

Group 3 Fabrics

- 1x CA-SSEF30-22
- 1x CA-SSF30-100-22
- 3x CA-SSLF30-22
- 1x CA-SSF30-100-10
- 1x CA-SSLF30-15
- 2x CA-SSF30-75-15
- 3x CA-SSF30-75-22
- 1x CA-SSF30-75-10
- 1x CA-SSEF30-10
- 1x CA-SFPB-2-L
- 1x CA-SFPB-2-R
- 1x CA-ST-140

W6650 x D1600
x H2200mm

NOTE: Loose Calvert accessories such as shelves, panels & weaves shown, along with additional furniture pieces, are not included in the above pricing.



Product Codes

Two Person Booth
Group 3 Fabrics

5x CA-SSF30-75-22
2x CA-SSEF30-22
4x CA-SSLF30-22
2x CA-SSCK30-22
1x CA-SFPB-1-L
1x CA-SFPB-1-R
1x CA-ST-100-MFC
1x CA-BCP-2P

Dimensions

W2950 x D1140
x H2200mm

Product Codes

Meeting Pod Room
Group 3 Fabrics

4x CA-DSF60-100-22
3x CA-DSF60-75-22
2x CA-DSCK60-22
4x CA-DSL60-22
2x CA-DSPEF60-22
4x CA-CB-23

Dimensions

W3500 x D2650
x H2200mm

Product Codes

Angled Office Trio

1x CA-TRCK-22
6x CA-DSF60-100-22
3x CA-DSL60-22
3x CA-DSSF60-22
3x CA-ST-140

Dimensions

W4150 x D3600
x H2200mm

Product Codes

Mobile Planter Wall

2x CA-DSF60-75-15
+ CASTORS
2x CA-DSEF60-15
4x CA-BX-TR

Dimensions

W1550 x D600
x H1550mm



Product Codes

4 Person Standard Height Collaboration Table

1x CA-CT-4S
2x CA-DSF60-22-10
2x CA-DSL60-10
2x CA-DSPEF60-10

Dimensions

W3600 x D1200
x H1200mm

Product Codes

6 Person Poseur Height Collaboration Table with Beams

1x CA-CT-6P
1x CA-CT-6B
2x CA-DSF60-75-22
2x CA-DSL60-22
2x CA-DSEF60-22

Dimensions

W3850 x D1200
x H2200mm

Product Codes

Mobile AV Divider
Group 3 Fabric

2x CA-SSF30-75-15
+ OUTRIGGER CASTORS
2x CA-SSPEF30-15
1x CA-AV-LRG

Dimensions

W1550 x D650
x H1550mm

Product Codes

Mobile Presentation Divider Wall

2x CA-DSF60-100-22
+ OUTRIGGER CASTORS
2x CA-DSSF60-22
2x CA-DWL-100-FULL
2x CA-BX-SQ
2x CA-BX-TR

Dimensions

W2050 x D900
x H2250mm

NOTE: Loose Calvert accessories such as shelves, panels & weaves shown, along with additional furniture pieces, are not included in the above pricing.



WALL HEIGHTS:

All walls & storage walls available in three heights



Low
H1000mm
Replace 'xx' with '10'



Mid
H1500mm
Replace 'xx' with '15'



High
H2200mm
Replace 'xx' with '22'

SINGLE SIDED WALLS:

Illustrations show mid height option



750mm Wide
CA-SSF30-75-xx
W750 x D338mm



1000mm Wide
CA-SSF30-100-xx
W1000 x D338mm



750mm Wide Storage Wall
CA-SSCB30-75-xx
W750 x D600mm



1000mm Wide Storage Wall
CA-SSCB30-100-xx
W1000 x D600mm

Single Sided Wall frames must be wall or floor fixed, unless used in self-supporting layouts.

DOUBLE SIDED WALLS:

Illustrations show mid height option



750mm Wide
CA-DSF30-75-xx
W750 x D600mm



1000mm Wide
CA-DSF30-100-xx
W1000 x D600mm



750mm Wide Storage Wall
CA-DSCB30-75-xx
W750 x D600mm



1000mm Wide Storage Wall
CA-DSCB30-100-xx
W1000 x D600mm

For additional stability Wall Frames can be floor fixed. Alternatively, Steel weighted ballasts can be fitted to base panels

Tops of High Walls used in open atrium areas can be supplied with additional top panels to cap off visibility of fixings or cabling.

PLANTERS

Add planters to top of Low or Mid Frames. Solid finish options as per Wall Frames.

	750mm Wide Single Sided	750mm Wide Double Sided	1000mm Wide Single Sided	1000mm Wide Double Sided
Product Code	+PL	+PL	+PL	+PL

Note: Plants not included. For real planting a waterproof flexible lining is required.



CASTORS



Outrigger Feet

Optional castors make wall frames mobile, for added flexibility in open-plan spaces. (Maximum 3 Walls linked)

Double Sided Low & Mid Walls only require plain castors. Single Sided Walls and High Double Sided Walls include outrigger feet.

Adding Castors increases height by 50mm



END FRAMES:

End Frames need to be fitted to the ends of all wall runs, capping off fixing holes, aiding rigidity and creating an enclosed frame appearance.

When additional rigidity is required, such as when Drop-in Desks are used, Slatted or Panelled End Frames are recommended.

Panelled End Frames available in Birch Ply, Valchromat, Bamboo or Upholstered.

END FRAMES



Single Sided

Double Sided

Product Code

Low: CA-SSEF30-10
Mid: CA-SSEF30-15
High: CA-SSEF30-22

Low: CA-DSEF60-10
Mid: CA-DSEF60-15
High: CA-DSEF60-22

Dimensions

W25 x D338 x
H1000/1500/2200mm

W25 x D600 x
H1000/1500/2200mm

SLATTED END FRAMES



Single Sided

Double Sided

Product Code

Low: CA-SSSF30-10
Mid: CA-SSSF30-15
High: CA-SSSF30-22

Low: CA-DSSF60-10
Mid: CA-DSSF60-15
High: CA-DSSF60-22

Dimensions

W25 x D338 x
H1000/1500/2200mm

W25 x D600 x
H1000/1500/2200mm

PANELLED END FRAMES



Single Sided

Double Sided

Product Code

Low: CA-SSPEF30-10
Mid: CA-SSPEF30-15
High: CA-SSPEF30-22

Low: CA-DSPEF60-10
Mid: CA-DSPEF60-15
High: CA-DSPEF60-22

Dimensions

W25 x D338 x
H1000/1500/2200mm

W25 x D600 x
H1000/1500/2200mm



LINK FRAMES & CORNER KITS:

Link Frames allow walls of varying heights to be connected, as well as providing fixing points for Corner Kits.

Corner Kits allow for two, three or four walls to be joined at triangular or square intersections. Create a simple change of direction, or link several wall runs together to create multiple enclosed areas.

Powder coated metalwork available in standard colours, as per frames.
Panel elements available in Natural Birch Ply, Valchromat in Light Grey or Black.

LINK FRAMES



	Single-Sided	Double-Sided
Product Code	Low: CA-SSLF30-10 Mid: CA-SSLF30-15 High: CA-SSLF30-22	Low: CA-DSLF60-10 Mid: CA-DSLF60-15 High: CA-DSLF60-22
Dimensions	W25 x D338 x H1000/1500/2200mm	W25 x D600 x H1000/1500/2200mm

CORNER KITS





	Low	Mid	High
SINGLE SIDED	2-Way: CA-SSCK30-10-2W 3-Way: CA-SSCK30-10-3W 4-Way: CA-SSCK30-10-4W	2-Way: CA-SSCK30-15-2W 3-Way: CA-SSCK30-15-3W 4-Way: CA-SSCK30-15-4W	2-Way: CA-SSCK30-22-2W 3-Way: CA-SSCK30-22-3W 4-Way: CA-SSCK30-22-4W
Dimensions	W338 x D338 x H1000mm	W338 x D338 x H1500mm	W338 x D338 x H2200mm
DOUBLE SIDED	2-Way: CA-DSCCK60-10-2W 3-Way: CA-DSCCK60-10-3W 4-Way: CA-DSCCK60-10-4W	2-Way: CA-DSCCK60-15-2W 3-Way: CA-DSCCK60-15-3W 4-Way: CA-DSCCK60-15-4W	2-Way: CA-DSCCK60-22-2W 3-Way: CA-DSCCK60-22-3W 4-Way: CA-DSCCK60-22-4W
Dimensions	W600 x D600 x H1000mm	W600 x D600 x H1500mm	W600 x D600 x H2200mm
DOUBLE TO SINGLE SIDED	2-Way: CA-DSSCK-10-2W 3-Way: CA-DSSCK-10-3W 4-Way: CA-DSSCK-10-4W	2-Way: CA-DSSCK-15-2W 3-Way: CA-DSSCK-15-3W 4-Way: CA-DSSCK-15-4W	2-Way: CA-DSSCK-22-2W 3-Way: CA-DSSCK-22-3W 4-Way: CA-DSSCK-22-4W
Dimensions	W338 x D600 x H1000mm	W338 x D600 x H1500mm	W338 x D600 x H2200mm
TRIANGULAR	2-Way: CA-TRCK-10-2W 3-Way: CA-TRCK-10-3W	2-Way: CA-TRCK-15-2W 3-Way: CA-TRCK-15-3W	2-Way: CA-TRCK-22-2W 3-Way: CA-TRCK-22-3W
Dimensions	W600 x D520 x H1000mm	W600 x D520 x H1500mm	W600 x D520 x H2200mm



				
	W700mm Shelf	W950mm Shelf		
Product Code	CA-SH-70	CA-SH-95		
Dimensions	W700 x D265mm	W950 x D265mm		
				
	Square Box	Rectangular Box	Square Cupboard With Push to Open catch	Trough Box*
Product Code	CA-BX-SQ	CA-BX-RT	CA-BX-SQC	CA-BX-TR
Dimensions	W500 x H500 x D285mm	W700 x H200 x D285mm	W500 x H500 x D285mm	W700 x H200 x D285mm

* Plants not included.
For real planting a waterproof lining is required.



			
	Small AV Box Fits up to 28" screen	Large AV Box Fits up to 40" screen	AV Panel For screens over 40"
Product Code	CA-AV-SML	CA-AV-LRG	CA-AV-PL
Dimensions	W750 x H500 x D150mm	W1000 x H700 x D150mm	W1000 x H700mm

As they are screen specific
AV Mounting kits are not
supplied.

Kit can be fixed at any point
to panels using self-tapping
screws.

Bamboo AV panels require
pilot holes drilling to reduce
risk of splitting.

FINISHES:



Powder coated metalwork available in 21 RAL or 3 Premium colours.



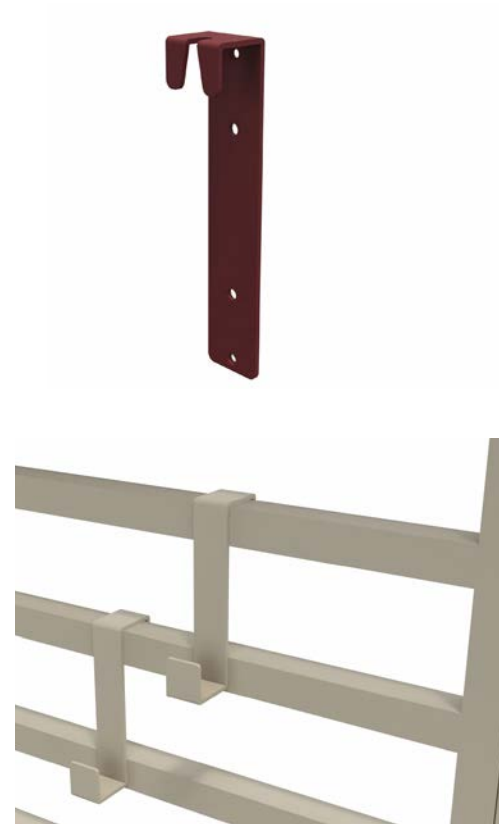

Shelf inserts, display & AV box frames and AV Panel in Plywood, Bamboo or Valchromat finishes.

For full list of finishes refer to p.30-31



Saddle Brackets can be fastened to customer's own accessories to allow fixing to wall frames.

ACCESSORIES

				
	S-Hook	Optic	Magnets Set of 4no.	Saddle Bracket
Product Code	CA-HOOK	CA-OPT	CA-MAGS	CA-SADL
Dimensions	W25 x D67 x H125mm	W80 x W80 x H380mm	W10 x D10 x H10mm	W40 x D35 x H205mm



Powder coated S-Hook, Optic bracket or Saddle Bracket available in 12 Standard or 3 Premium colours. For Premium colour no upcharge needed, although minimum order may apply if ordering in isolation.

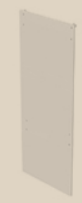

LAMINATE WHITEBOARDS

					
	Square Laminates	H700mm x W750mm Laminates	H700mm x W1000mm Laminates	Full Height x W750mm Laminates	Full Height x W1000mm Laminates
Product Code	CA-DWL-50-50	CA-DWL-75-70	CA-DWL-100-70	CA-DWL-75-FULL	CA-DWL-100-FULL
Dimensions	W500 x H500mm	W750 x H700mm	W1000 x H700mm	W750 x H1825mm	W1000 x H1825mm





GLASS MAGNETIC WHITEBOARDS

			
	Square Glass	H650mm x W1000mm Glass	Full Height x W1000mm Glass
Product Code	CA-DWG-50-50	CA-DWG-100-65	CA-DWG-100-FULL
Dimensions	W500 x H500mm	W1000 x H650mm	W1000 x H1825mm





Calvert



UPHOLSTERED PANELS

				
	Square	Rectangular	H500 x W750mm	H500 x W1000mm
Product Code	CA-UP-50-50	CA-UP-70-20	CA-UP-75-50	CA-UP-100-50
Dimensions	W500 x H500mm	W700 x H200mm	W750 x H500mm	W1000 x H500mm

Fabric Upholstery over plywood with acoustic foam padding.
Large panels may include central seam to reduce fabric waste.

				
	H700 x W750mm	H700 x W1000mm	Full Height x W750mm	Full Height x W1000mm
Product Code	CA-UP-75-70	CA-UP-100-70	CA-UP-75-FULL	CA-UP-100-FULL
Dimensions	W750 x H700mm	W1000 x H700mm	W750 x H1825mm	W1000 x H1825mm





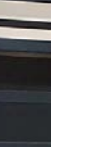

FABRIC WEAVES

		
	Cupboard Height Set of 4	Full Height Set of 4
Product Code	CA-CH-WV	CA-FH-WV
	Fabric weaves only available in multiples of 4no. Magnetic fixings included.	

Calvert







SIDE FIX SEATING



				
	Single Bench	Double Bench	Single Park Bench	Double Park Bench
Product Code	Right: CA-SFB-1-R Left: CA-SFB-1-L	Right: CA-SFB-2-R Left: CA-SFB-2-L	Right: CA-SFPB-1-R Left: CA-SFPB-1-L	Right: CA-SFPB-2-R Left: CA-SFPB-2-L
Dimensions	W750 x H800 x D750 x SH475mm	W1500 x H800 x D750 x SH475mm	W750 x H800 x D750 x SH475mm	W1500 x H800 x D750 x SH475mm

Please Note: Illustrations show Right arm units.



REAR FIX SEATING

				
	Single Bench	Double Bench	Single Park Bench	Double Park Bench
Product Code	CA-RFB-1	CA-RFB-2	CA-RFPB-1	CA-RFPB-2
Dimensions	W750 x H800 x D750 x SH475mm	W1500 x H800 x D750 x SH475mm	W750 x H800 x D750 x SH475mm	W1500 x H800 x D750 x SH475mm



CROSS BEAMS			
Product Code	CA-CB-15	CA-CB-23	CA-CB-30
Dimensions	W1550 X D150mm	W2300 X D150mm	W3000 X D150mm

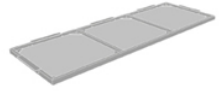
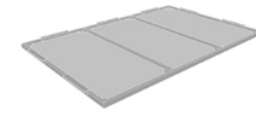

CEILING FRAMES				
Product Code	CA-BCP-2P	CA-BCP-4P	CA-BCS-2P	CA-BCS-4P
Dimensions	W2300 X D800mm	W2300 X D1550mm	W2300 X D800mm	W2300 X D1550mm

Use Ceiling Frames with High Wall Units to create intimate booth-type shelters within open plan spaces.
Customer's own lighting can be fitted to ceiling boards or beams.

Calvert

Collaboration Tables provide open meeting spaces between Double Sided Wall Frames (not included in price).

Appropriate height Linking frames are required.



Calvert

COLLABORATION TABLE BEAMS

	4-Person Table Beams	6-Person Table Beams
Product Code	CA-CT-4B	CA-CT-6B
Dimensions	W1500 x D600mm	W2250 x D600mm



Beams in power coated colours with panels in Plywood, Bamboo or Valchromat finishes.

Beams can only be used between High Wall Frames.

COLLABORATION TABLES

	4-Person Table Standard Height	4-Person Table Poseur Height	6-Person Table Standard Height	6-Person Table Poseur Height
Product Code	CA-CT-4S	CA-CT-4P	CA-CT-6S	CA-CT-6P
Dimensions	W1500 x D1200 x H775mm	W1500 x D1200 x H1050mm	W2250 x D1200 x H775mm	W2250 x D1200 x H1050mm

Powder coated metalwork available in 21 RAL or 3 Premium colours.

LAMINATE TABLE TOPS:

White	China Red U321	Rusty Red U335	Sand Yellow U125	Almond Beige U211	Carat Beige U115
Black	Midnight Blue U570	Baltic Blue U545	Fir Green U699	Stone Green U665	Reed Green U604

Laminate tops have radius corners.



SOLID TABLE TOPS:

Birch Plywood*	Grey Valchromat	Black Valchromat	Natural Bamboo	Caramel Bamboo

Solid Tops have square corners.



TABLES

	Small Standard Height	Small Poseur Height	Large Standard Height	Large Poseur Height
Product Code	CA-ST-100	CA-PT-100	CA-ST-140	CA-PT-140
Dimensions	W750 x D1000 x H725mm	W750 x D1000 x H1025mm	W750 x D1400 x H725mm	W750 x D1400 x H1025mm

FINISHES:



Powder coated metalwork available in 21 RAL or 3 Premium colours.

Tops in MFC, PerfectSense, Plywood, Bamboo or Valchromat finishes.

For full list of finishes refer to p.30-31



Drop-in Desks are hooked onto wall frames allowing for flexibility in working height.

When Drop-in Desks are specified either Slatted or Panelled End Frames should be used to reduce any movement in the frame.

Drop-in Desks include an upholstered modesty panel in **Camira Blazer/Synergy** to match chosen metalwork finish. See chart below for colour pairings.

Alternatively if upholstered panels are included on the scheme modesty panels will be made to match.

DROP-IN DESKS

	W750mm	W1000mm	W1500mm	W2000mm
Product Code	CA-DID-75	CA-DID-100	CA-DID-150	CA-DID-200
Dimensions	W750 x D600mm	W1000 x D600mm	W1500 x D600mm	W2000 x D600mm

FINISHES:



Powder coated metalwork available in 21 RAL or 3 Premium colours.
 Tops in MFC, PerfectSense, Plywood, Bamboo or Valchromat finishes.
 For full list of finishes refer to **p.30-31**

CABLE SNAKES

	Short Fabric Cable Snake	Long Fabric Cable Snake
Product Code	CA-SNAKE-S	CA-SNAKE-L
Dimensions	Length: 625mm	Length: 925mm

Cable Snake Finishes:

Fabric snake in Camira Blazer/Synergy colours to match metalwork, see facing page.
 Alternatively if upholstered panels are included on the scheme snakes can be made to match.
 Zip fastening with magnetic attachment to 'Calvert' frame.

Please specify when ordering.
 Custom fabrics & lengths available on request. P.O.A.

	Wine Red RAL 3005	=		Amiable LDS79		Pebble Grey RAL 7032	=		Chain LDS19						
	Ruby Red RAL 3003	=		Wellington CUZ13		Grey Beige RAL 1019	=		Fairfield CUZ47						
	Beige Red RAL 3012	=		Work LDS73		Yellow Grey RAL 7034		Cement Grey RAL 7033	=		Bracket LDS23				
	Broom Yellow RAL 1032		Zinc Yellow RAL 1018	=		Eynesbury CUZ2W		Fir Green RAL 6009		Moss Green RAL 6005		Reseda Green RAL 6011	=		Cardiff CUZIN
	Oyster White RAL 1013	=		Dartmouth CUZ2Q		Graphite Grey RAL 7024	=		Bromsgrove CUZ35						
	Steel Blue RAL 5011	=		Glenalmond CUZ62		Jet Black RAL 9005	=		Napier CUZ08						
	Sapphire Blue RAL 5003		Pigeon Blue RAL 5014	=		Edinburgh CUZ1Y		Quartz PREMIUM	=		Trevelyan CUZ31				
	Blue Grey RAL 7031	=		Abelour CUZ1J		Golden Brown PREMIUM	=		Affix LDS32						
	Signal White RAL 9003		Light Grey RAL 7035	=		Silverdale CUZ28		Rust Mica PREMIUM	=		Cordial LDS78				

METAL FINISHES:

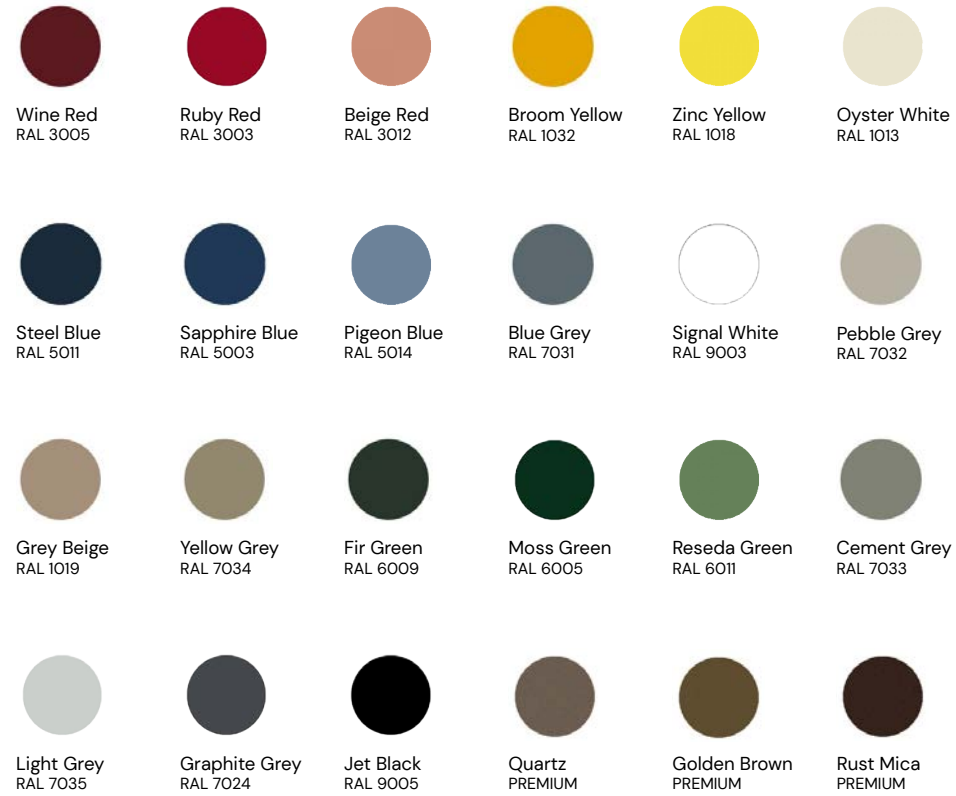

SOLID MATERIALS:



CUPBOARDS & DISPLAY BOXES:



Custom finishes available on request. P.O.A.

MFC - CUPBOARDS & TABLETOPS:

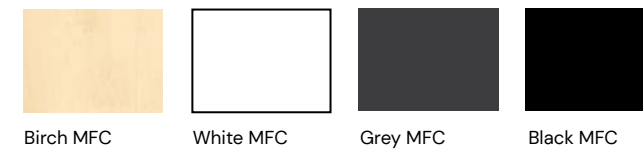

PERFECTSENSE - CUPBOARDS & TABLETOPS:



***Birch Plywood Note:** We use a high quality plywood board with a water-based clear lacquer. While care is taken to avoid any large knots or visible plugs these may still appear and are in keeping with the natural appearance of the material.

Calvert

PRODUCT MATERIAL BREAKDOWN

Material Breakdown Data based on example **Calvert** setup with Bamboo panels using the following parts:
 3x CA-DSF60-75-22
 2x CA-DSEF60-22
 8x CA-SH-70
 4x CA-BX-SQ

Figures stated will vary depending on components & finishes used.

Recycled data based on supplier information and industry averages. As part of our continuous development processes we will review this information regularly and data may change without notice.

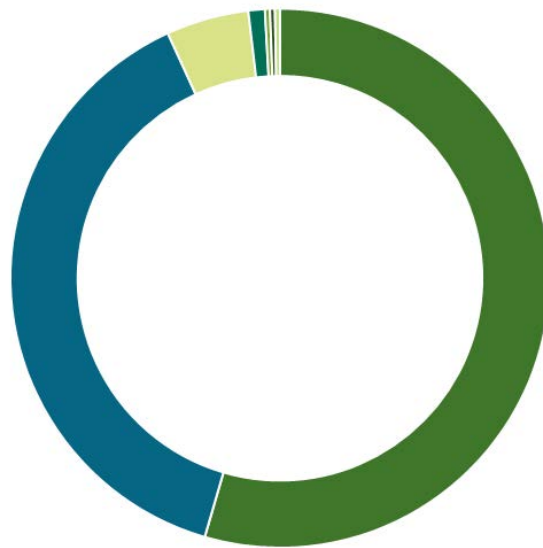

55%	MILD STEEL
39%	BAMBOO
5%	MELAMINE FACED MDF
1%	POLYESTER POWDER COAT
<1%	PLATED MILD STEEL FIXINGS
<1%	PU

TOTAL WEIGHT: 257kg

429.29 KG CO₂e
*calculations are based on average emission factors validated by third-party open data sources based on cradle-to-gate phases of typical product lifecycle.

SUSTAINABILITY

33%	RECYCLED CONTENT
99%	RECYCLABLE

This product has been designed using high quality materials and craftsmanship to ensure it's longevity, however at the end of this products life it can be returned to **sixteen3** for refurbishment or recycling.

For FSC® Chain of Custody specify when ordering.



Warranty Information

5 YEAR - NORMAL FAIR WEAR & TEAR

This includes the structure and any foam/padding materials. Fabrics are covered by fabric manufacturers' warranties, usually 5 years, dependant on fabric choice.

Please refer to full **sixteen3** Warranty information document for more details. **sixteen3** ltd reserve the right to update product data information without prior notice.

Cleaning & Maintenance

GENERAL MAINTENANCE

- Vacuum upholstery regularly to remove dust and grit.
- Most hard surfaces can be cleaned with a soft cloth, dampened with a small amount of water and buffed dry.
- Clean spills and stains quickly to prevent them setting in (see specific fabric care instructions below).
- If being used in a spill/stain prone area specify an appropriate finish with stain-repellent properties.

Refer to fabric manufacturers own guidelines for specific information.

NATURAL FABRICS

In addition to regular vacuuming, wool and other natura fibres can usually be cleaned using appropriate upholstery shampoo. For a deeper clean it is best that wool be dry cleaned, as over-wetting can cause shrinkage and appearance change. Never apply bleach, ammonnia, alkali or strong acids to wool upholstery.

SYNTHETIC FABRICS

Vacuuming is the best regular maintenance followed by speed of action to remove spills and stains rapidly as soon as they occur. Most synthetic fabrics can be wiped down with a water soaked damp cloth without fear of damaging fibre or removing colour. Stubborn stains can be removed with a quality upholstery shampoo.

LEATHER

Leather should be regularly dusted with a soft cloth and vacuumed with a soft brush extension. Most types of aniline can also be treated with specialist products to help preserve colour/finish etc. As leather is a natural material, discrepancies in surface texture and 'puddling' in seat areas is to be expected.

WOOD FINISHES

Clean surfaces regularly with a slightly damp cloth and buff dry with a soft duster. The finish on all wood and laminate surfaces is designed to withstand moderate heat and some spillages, but all spillages should be wiped off with a damp cloth straight away. Do not drag any objects across any table tops. Certain wood finishes will naturally change in appearance with age. We cannot guarantee an exact match of any timber products.

POWDER COATED & PAINTED

Clean surfaces regularly with a slightly damp cloth and a mild solution of soapy water. Buff dry with a soft duster.

PLASTICS

Clean surfaces regularly with a slightly damp cloth and a mild solution of soapy water. Buff dry with a soft duster.



+44 1925 850500
info@sixteen3.co.uk
@sixteen3_ltd

HQ:
Unit 2, Westway21
Chesford Grange,
Woolston, Warrington
WA1 4SZ

London:
25 Bastwick St
Clerkenwell
London
EC1V 3PS

Manchester:
Material Source Studio
1 Federation St
NOMA
Manchester
M4 4BF

Glasgow:
Material Source Studio
180 West George Street
Glasgow, G2 2NR

sixteen3.co.uk